

Vive Comfort

P.O. Box 3377
 Springfield, MO 65808-3377
 Toll Free : 888-776-1427
 Web: www.vivecomfort.com
 Hours of Operation: M-F 9AM - 6PM Eastern

Thermostat Application Guide

Description	
Gas or Oil Heat	Yes
Electric Furnace	Yes
Heat Pump (No Aux. or Emergency Heat)	Yes
Heat Pump (With Aux. or Emergency Heat)	Yes
Multi-Stage Systems	Yes
Heat Only Systems	Yes
Cool Only Systems	Yes
Millivolt	Yes

Table of Contents

Table of Contents	Page
Installation Tips	2-4
Thermostat Quick Reference	5-7
Private Label Badge	8
Wiring	9-10
Wiring Diagrams	11-12
Technician Setup Menu	13-18
Programming	19-26
Features	27-28
Specifications	29

Power Type

Battery Power
 Hardwire (Common Wire)
 Hardwire (Common Wire) with Battery Backup

A trained, experienced technician must install this product.

Carefully read these instructions. You could damage this product or cause a hazardous condition if you fail to follow these instructions.

Una version en español de este manual se puede descargar en la pagina web de la compañía.

Wall Locations

The thermostat should be installed approximately 4 to 5 feet above the floor. Select an area with average temperature and good air circulation.

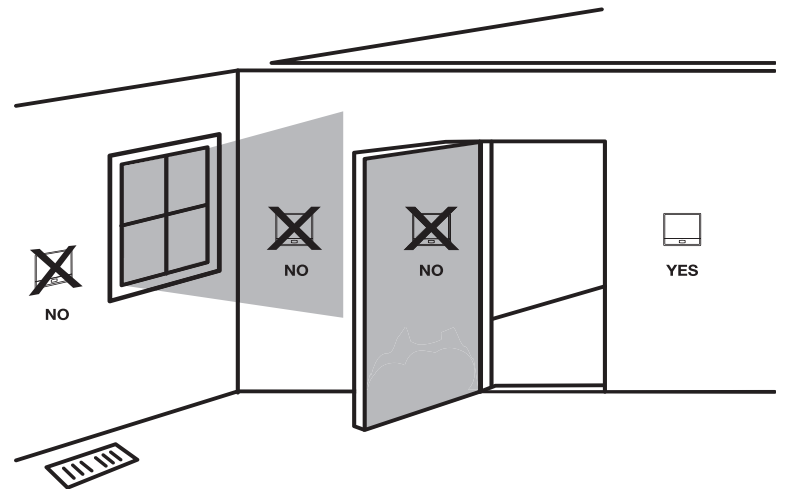

Do not install thermostat in these locations:

- Close to hot or cold air ducts
- That are in direct sunlight
- With an outside wall behind the thermostat
- In areas that do not require conditioning
- Where there are dead spots or drafts (in corners or behind doors)
- Where there might be concealed chimneys or pipes

Installation Tip

Pick an installation location that is easy for the user to access. The temperature of the location should be representative of the building.

Installation Tips

Subbase Installation

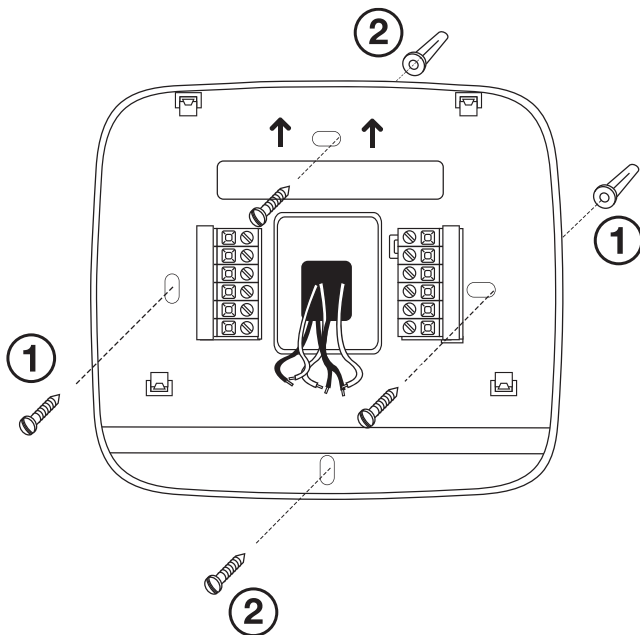

- 1 Horizontal Mount** For horizontal mount put one screw on the left and one screw on the right.
- 2 Vertical Mount** For vertical mount put one screw on the top and one screw on the bottom.

Installation Tip: Electrical Hazard

Failure to disconnect the power before beginning to install this product can cause electrical shock or equipment damage.

Mercury Notice

All of our products are mercury free. However, if the product you are replacing contains mercury, dispose of it properly. Your local waste management authority can give you instructions on recycling and proper disposal.

Installation Tips

Mount Thermostat

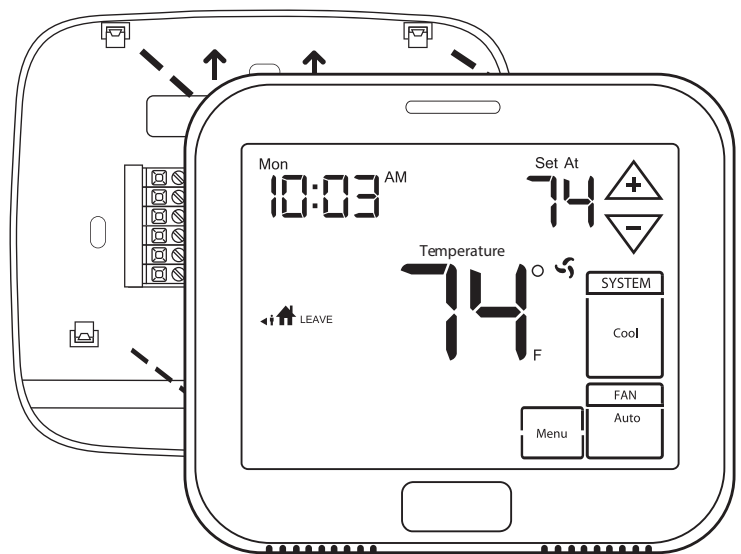

Align the 4 tabs on the subbase with corresponding slots on the back of the thermostat, then push gently until the thermostat snaps in place.

Note: To ensure a solid fit between the thermostat and the subbase:

1. Mount subbase to a flat wall
2. Use screws provided
3. Drywall anchors should be flush with the wall
4. Wires should be pushed into the wall

Battery Installation

Battery installation is recommended even if the thermostat is hardwired (C terminal connected). When the thermostat is hardwired and batteries are installed, the thermostat will activate a compressor delay of 5 minutes when it detects a power outage from the hardwired power supply.

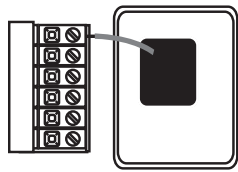

Important:

High quality alkaline batteries are recommended. Rechargeable batteries or low quality batteries do not guarantee a 1-year life span.

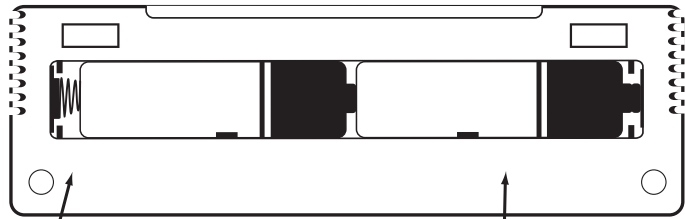

On the back of the thermostat insert 2 AA Alkaline batteries (included).

Insert 2 AA Alkaline batteries (included). High quality alkaline batteries are recommended.

Wiring



Caution: Electrical Hazard

Failure to disconnect the power before beginning to install this product can cause electrical shock or equipment damage.



Warning:

All components of the control system and the thermostat installation must conform to Class II circuits per the NEC Code.

Wiring

1. If you are replacing a thermostat, make note of the terminal connections on the thermostat that is being replaced. In some cases the wiring connections will not be color coded. For example, the green wire may not be connected to the **G** terminal.
2. Loosen the terminal block screws. Insert wires then retighten the terminal block screws.
3. Place nonflammable insulation into the wall opening to prevent drafts.



Installation Tip

Do not overtighten terminal block screws, as this can damage the terminal block. A damaged terminal block can keep the thermostat from fitting on the subbase correctly or cause system operation issues.

Max Torque = 6in-lbs.

Wiring Tips

C Terminal

The C (common wire) terminal does not have to be connected when the thermostat is powered by batteries.

Note:

In many heat pump systems with no emergency heat relay, a jumper can be installed between **E** and **W2** to turn thermostat into a single stage control for Emergency Heat Operation.

Wire Specifications

Use shielded or non-shielded 18-22 gauge thermostat wire.

Getting to know your thermostat

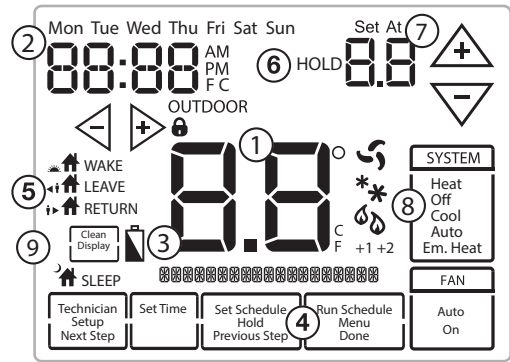

- 1 **Indicates the current room temperature**
- 2 **Time and day of the week**
- 3 **Low Battery Indicator:** Replace batteries when this indicator is shown.
- 4 **Program Menu Options:** Show different options during programming.
- 5 **Period Icons** - This thermostat can have 2 or 4 programmable time periods per day. Icons are displayed for 4 time periods. Occupied and Unoccupied will display in the text field for 2c and 4c time periods.
- 6 **HOLD** is displayed when thermostat program is permanently overridden.
- 7 **Setpoint:** Displays the user selectable setpoint temperature
- 8 **System Operation Indicators:** The COOL, HEAT or FAN icon will display when the COOL, HEAT or FAN is on. NOTE: The compressor delay feature is active if these icons are flashing. The compressor will not turn on until the 5 minute delay has elapsed.
- 9 **Clean Display:** Will disable screen for 30 seconds to allow cleaning.



Important

The low battery indicator is displayed when the AA battery power is low. If the user fails to replace the battery within 21 days, the screen will only show the low battery indicator but maintain all functionality. If the user fails to replace the batteries after an additional 21 days (days 22-42 since first "low battery" display) the setpoints will change to 55°F (Heating) and 85°F (Cooling). If the user adjusts the setpoint away from either of these, it will hold for 4 hours then return to either 55°F or 85°F. After day 63 the batteries must be replaced immediately to avoid freezing or overheating because the thermostat will shut the unit off until the batteries are changed.

Wiring

Terminal Designations

This thermostat is shipped from the factory to operate a conventional heating and cooling system. This thermostat may also be configured for a heat pump system. See the "heat pump" configuration step on page 17 of this manual to configure the thermostat for heat pump applications.

Terminal	2 Heat 2 Cool Conventional System	2 Heat 2 Cool Heat Pump System	3 Heat 2 Cool Heat Pump System
RC	Transformer power (cooling)	Transformer power (cooling)	Transformer power (cooling)
RH	Transformer power (heating)	Transformer power (heating)	Transformer power (heating)
C	Transformer common	Transformer common	Transformer common
B	Energized in heating	Heat pump changeover valve energized in heating	Heat pump changeover valve energized in heating
O	Energized in cooling	Heat pump changeover valve energized in cooling	Heat pump changeover valve energized in cooling
G	Fan relay	Fan relay	Fan relay
W/E	First stage of heat	First stage of emergency heat	First stage of emergency heat
Y	First stage of cool	First stage of heat & cool	First stage of heat & cool
Y2	Second stage of cool	Second stage of cool	Second stage of cool & second stage of heat
W2	Second stage of heat	Auxiliary heat relay, second stage of heat	Auxiliary heat relay, third stage of heat

Getting to know your thermostat

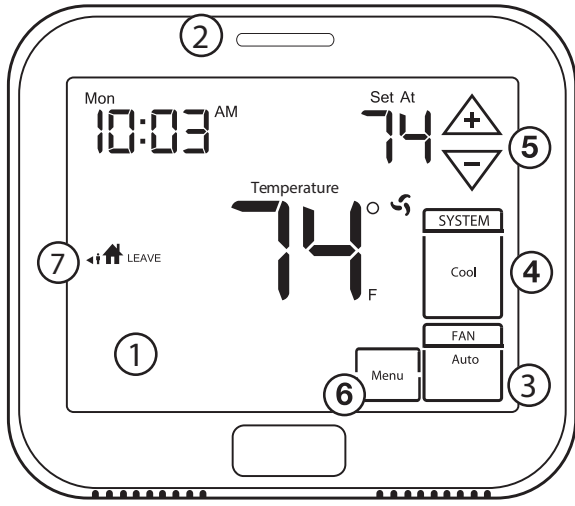

- ① LCD Display
- ② Glow in the dark light button
- ③ Fan Key
- ④ System Key
- ⑤ Setpoint buttons
- ⑥ Menu button
- ⑦ Scheduled time period Icons

About The Badge

All of our thermostats use the same universal magnetic badge. Visit the company website to learn more about our free private label program.

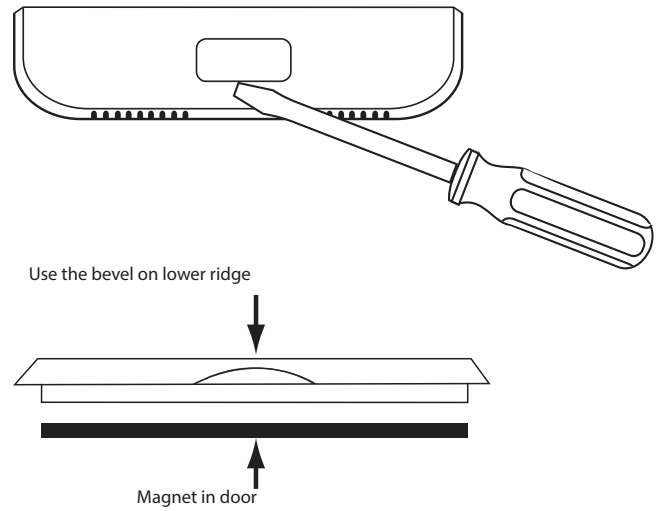

Gently slide a screwdriver into the bottom edge of the badge. Gently turn the screwdriver counter clockwise. The badge is held on by a magnet in the well of the battery door. The badge should pry off easily. **DO NOT USE FORCE.**

7

Wiring Diagrams

- ① Power supply
- ② Factory-installed jumper. Remove only when installing on 2-transformer systems

Typical 2H/2C System: 1 Transformer

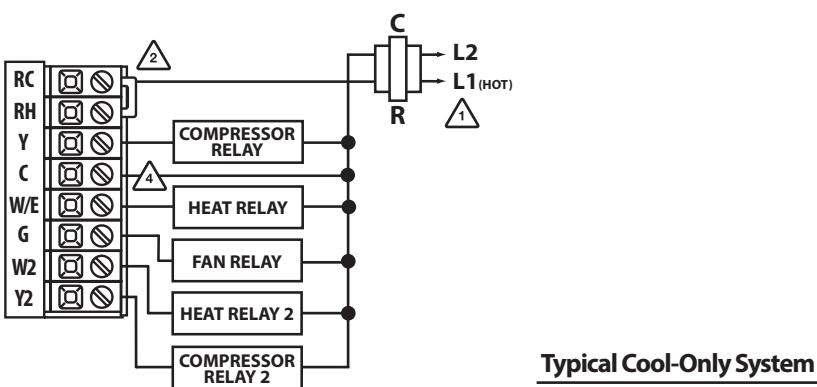

Typical Cool-Only System

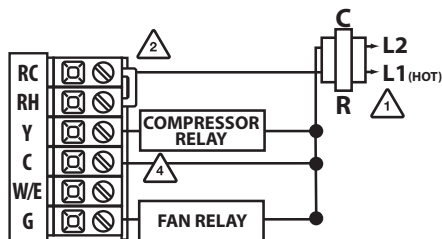

Typical Heat Only System With Fan

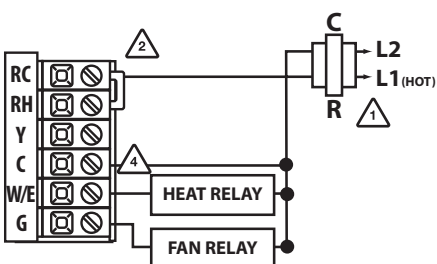

Wiring Diagrams

- ③ Use either O or B terminals for changeover valve
- ④ Optional 24 VAC common connection when thermostat is used in battery power mode

Typical 2H/2C System: 2 Transformer

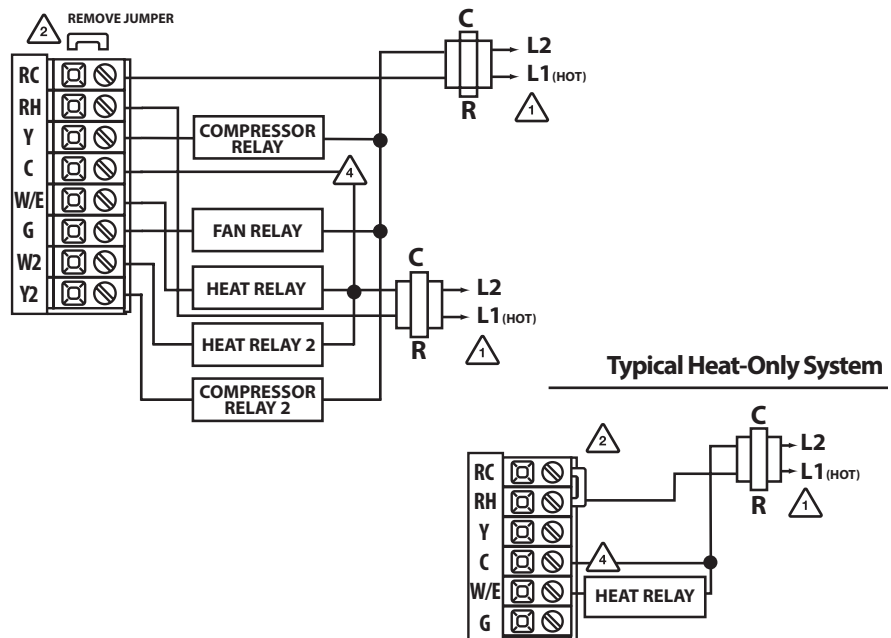

Typical Heat-Only System

Typical 3H/2C or 2H/1C Heat Pump System

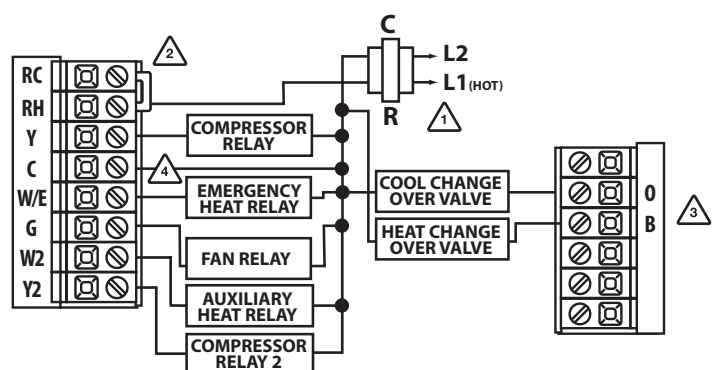



11





12

Technician Setup Menu

This thermostat has a technician setup menu for easy installer configuration. To set up the thermostat for your particular application:



1. Press the **MENU** button.
2. Press and hold the **TECHNICIAN SETUP** button for 3 seconds. This 3 second delay is designed so that homeowners do not accidentally access the installer settings.
3. Configure the installer options as desired using the table below. Use the  or  keys to change settings and the **NEXT STEP** or **PREV STEP** key to move from one step to another. **Note:** Only press the **DONE** key when you want to exit the Technician Setup options.
4. Press the **DONE** key to exit.

Tech Setup Steps	LCD Will Show	Adjustment Options	Default
Filter Change Reminder	OFF FILTER 0000	You can adjust the filter change reminder from "OFF" to 2000 hours of runtime in 50 hour increments.	OFF
Room Temperature Calibration	0 CALIBRATE	You can adjust the room temperature display to read up to 4° above or below the factory calibrated reading.	0°F
Minimum Compressor On Time	OFF ON AN MIN COMP	You can set the minimum compressor run time to "OFF", "3", "4", or "5" minutes. If 3, 4 or 5 is selected, the compressor will run for at least the selected time before turning off.	OFF

Keypad Lockout Note: The selected keypad lockout functionality must be activated after exiting tech setup. If you do not perform this procedure, all keys will function freely. To lock the keypad hold down the  and  keys for 3 seconds. You will see a lock in the display. To unlock the display hold down the  and  keys for 3 seconds.

Technician Setup Menu

Tech Setup Steps	LCD Will Show	Adjustment Options	Default
Compressor Short Cycle Delay	ON OF CO COMP DELAY	The compressor short cycle delay protects the compressor from "short cycling". This feature will not allow the compressor to be turned on for 5 minutes after it was last turned off.	ON
Cooling Swing	0.5 DF CO COOL SWING	The swing setting often called "cycle rate", "differential" or "anticipation" is adjustable. A smaller swing setting will cause more frequent cycles and a larger swing setting will cause fewer cycles.	0.5°
Heating Swing	0.4 DF HE HEAT SWING	The swing setting often called "cycle rate", "differential", or "anticipation" is adjustable. A smaller swing setting will cause more frequent cycles and a larger swing setting will cause fewer cycles.	0.4°
Keypad Lockout	PA KEY LOCK	Keypad lockout allows you to configure the thermostat so that some or all of the keys don't function.	OFF

PA= partial keypad lockout, which locks all the keys except the  or  keys.
FU= full keypad lockout, which locks out all the keys.

See Keypad Lockout Note



Swing Setting Tip

The second stage will turn on at 2x the swing setting. The second stage will turn off when 1x the swing is reached. For example, if the swing setting is .5 degrees for heating and the thermostat is set at 70°F, the first stage will turn on at approximately 69.5°F. The second stage will turn on at 69°F. The second stage will turn off at 69.5°F and the first will turn off at 70.5°F. If the third stage is used, it will turn on at 68.5°F and turn off at approximately 69°F.

13

14

Technician Setup Menu

Tech Setup Steps	LCD Will Show	Adjustment Options	Default
Heat Pump	OFF HEAT PUMP	OFF configures the thermostat for non heat pump systems. ON configures the thermostat for heat pump systems.	OFF
System Set	SYSTEM SET	Use the  or  key until the desired application is flashing. AUTO= Autochangeover	HEAT OFF COOL
Fan Operation	GAS FAN SET	GAS or ELEC	GAS
Dual Fuel Auxiliary for Heat Pump <small>Will only appear if Heat Pump setting is turned ON</small>	ON AG GAS AUX	OFF will allow Y(1st stage of Heat) and W2 (Aux Heat) to run together if called for. ON Will de-energize Y terminal 45 seconds after a call for Auxiliary Heat (W2).	OFF
Cooling Fan Delay	OFF COOL FAN DELAY	You can set the cooling fan delay to OFF, 15, 30, 60 or 90 seconds. If 15, 30, 60, or 90 is selected the fan will not turn on for that many seconds when there is a call for cool and will run for that many seconds after satisfying a call for cool.	OFF

Technician Setup Menu

Tech Setup Steps	LCD Will Show	Adjustment Options	Default
Stages of Heat	2H2C STAGE	You can configure the thermostat to operate a 3 stage heat pump system. 2H 2C = 2 heat, 2 cool 3H 2C = 3 heat, 2 cool This feature is shown only if the HEAT PUMP technician setup step is ON.	2 STAGES
Satisfy Setpoint	ON SS STAGING	This feature allows the thermostat to keep multiple stages of heat or cool energized until the setpoint is satisfied.	OFF
Staging Delay	5 STAGING D1	This feature allows a delay to occur if an additional stage is needed. This allows the previous stage extra time to satisfy the setpoint.	OFF

17

18

Tech Setup Steps	LCD Will Show	Adjustment Options	Default
Heating Temperature Setpoint Limit This feature allows you to set a maximum heating setpoint limit. The setpoint temperature cannot be raised above this value.		Use the ◀ or ▶ key to select the maximum heat setpoint.	90°F
Cooling Temperature Setpoint Limit This feature allows you to set a minimum cooling setpoint limit. The setpoint temperature cannot be lowered below this value.		Use the ◀ or ▶ key to select the minimum cool setpoint.	44°F
°F or °C This feature allows you to display temperatures in either Fahrenheit or Celsius.		°F for Fahrenheit °C for Celsius	°F
12 or 24 Hour Clock You can select either a 12 or 24 hour clock setting.		Use the ◀ or ▶ key to select 12 or 24 hour clock.	12 HOUR CLOCK
Morning Recovery This feature will start heating early to bring the building temperature to its programmed setpoint by the beginning of the WAKE, OCCUPIED time period.		Use the ◀ or ▶ key to turn on or off.	ON
Program Options You can configure this thermostat to have a 7 day program, a 5+1+1 program or as nonprogrammable.		Use the ◀ or ▶ key to select 7d for 7 day, 5d for 5+1+1, or 0d for nonprogrammable.	5d
Time Periods You can configure this thermostat to have 2 or 4 programmable time periods per day. 4 time periods are Wake, Leave, Return & Sleep. 2C time periods are Occupied & Unoccupied. 4C time periods are Occupied 1, Unoccupied 1, Occupied 2, & Unoccupied 2.		Use the ◀ or ▶ key to select 4, 2c, or 4c time periods per day.	4

Tech Setup Steps	LCD Will Show	Adjustment Options	Default
Pre-Occupancy Fan The pre-occupancy fan settings will energize the fan before the occupied time to provide ventilation prior to scheduled occupancy. This feature only shows if the technician setup step for time periods is set to 2C or 4C.		You can select the pre-occupancy fan from OFF, 1, 2, or 3 hours. If 1, 2, or 3 is selected, the fan will turn on that many hours prior to the scheduled occupied time period.	OFF
Always ON Light The display light can be configured to stay on all the time or come on when any key is pressed. NOTE: HARDWARE ONLY Keeping the display light continually "ON" will greatly reduce battery life.		Use the ◀ or ▶ key to turn on or off. OFF configures the display light to come on when the light key or any button is pressed. ON configures the display light to stay on.	OFF
Contractor Call Number Allows you to put your phone number in the display. You can choose ON or OFF.		If selected ON, you will see the input screen after pressing NEXT STEP . Use the ▲ or ▼ key to select the desired number and the ◀ or ▶ key to move from one character to another. See note below for operation.	OFF
Beep When any key is pressed an audible beep will sound. You can choose ON or OFF.		If ON is selected the beep will sound. If OFF is selected there is no sound.	ON

Contractor Call Number Note

If contractor call number is selected ON, the phone number entered will show in the display if there has been a continuous call for heating or cooling for 24 hours or if the light button is held down for 3 seconds. To remove the phone number from the display, hold the light button down for 3 seconds.

Programming

Set Time (If using programming)

Follow the steps below to set the day of the week and current time:

- Press the **MENU** button.
- Press **SET TIME**.
- Day of the week is flashing. Use the or key to select the current day of the week.
- Press **Next Step**.
- The current hour is flashing. Use the or key to select the current hour. When using 12-hour time, make sure the correct a.m. or p.m. choice is selected.
- Press **Next Step**.
- Minutes are now flashing. Use the or key to select current minutes.
- Press **DONE** when completed.

Programming

All our programmable thermostats are shipped with an energy saving default program. You can customize this default program by following the instructions in the **set program schedule section** starting on page 24.

Your thermostat can be programmed to have each day of the week programmed uniquely (7 days), all the weekdays the same with a separate program for Saturday and a separate program for Sunday (5+1+1), or non-programmable. For the 7-day and 5+1+1 programming modes, there are three time period options.

- "4" Residential (**WAKE, LEAVE, RETURN, SLEEP**)
- "2C" Commercial (**OCCUPIED, UNOCCUPIED**)
- "4C" Commercial (**OCCUPIED 1, UNOCCUPIED 1, OCCUPIED 2, UNOCCUPIED 2**)

This thermostat has a programmable fan feature, which allows you to run the fan continually during any time period.

Programming

Default Programming

Factory Default Program				
Day of the Week	Events	Time	Setpoint Temperature (HEAT)	Setpoint Temperature (COOL)
Weekday	Wake/OCC1	6 AM	70°F (21°C)	75°F (24°C)
	Leave/UNOCC1	8 AM	62°F (17°C)	83°F (28°C)
	Return/OCC2	6 PM	70°F (21°C)	75°F (24°C)
	Sleep/UNOCC2	10 PM	62°F (17°C)	78°F (26°C)
Saturday	Wake/OCC1	6 AM	70°F (21°C)	75°F (24°C)
	Leave/UNOCC1	8 AM	62°F (17°C)	83°F (28°C)
	Return/OCC2	6 PM	70°F (21°C)	75°F (24°C)
	Sleep/UNOCC2	10 PM	62°F (17°C)	78°F (26°C)
Sunday	Wake/OCC1	6 AM	70°F (21°C)	75°F (24°C)
	Leave/UNOCC1	8 AM	62°F (17°C)	83°F (28°C)
	Return/OCC2	6 PM	70°F (21°C)	75°F (24°C)
	Sleep/UNOCC2	10 PM	62°F (17°C)	78°F (26°C)

Default Programming

Factory Default Program for 2 Time Periods				
Day of the Week	Events	Time	Setpoint Temperature (HEAT)	Setpoint Temperature (COOL)
Weekday	OCCUPIED	8 AM	70°F (21°C)	72°F (22°C)
	UNOCCUPIED	6 PM	64°F (18°C)	80°F (27°C)
Saturday	OCCUPIED	8 AM	70°F (21°C)	72°F (22°C)
	UNOCCUPIED	6 PM	64°F (18°C)	80°F (27°C)
Sunday	OCCUPIED	8 AM	70°F (21°C)	72°F (22°C)
	UNOCCUPIED	6 PM	64°F (18°C)	80°F (27°C)





You can use the table on the next page to plan your customized program schedule if using 5+1+1.

Custom Program				
Day of the Week	Events	Time	Setpoint Temperature (HEAT)	Setpoint Temperature (COOL)
Weekday	Wake/OCC1			
	Leave/UNOCC1			
	Return/OCC2			
	Sleep/UNOCC2			
	Occupied			
	Unoccupied			
Saturday	Wake/OCC1			
	Leave/UNOCC1			
	Return/OCC2			
	Sleep/UNOCC2			
	Occupied			
	Unoccupied			
Sunday	Wake/OCC1			
	Leave/UNOCC1			
	Return/OCC2			
	Sleep/UNOCC2			
	Occupied			
	Unoccupied			

Set Program Schedule For Two Time Periods (OCCUPIED, UNOCCUPIED)

To customize your 5+1+1 Program schedule, follow these steps:

Weekday:

- Select **HEAT** or **COOL** with the **SYSTEM** key.
Note: You have to program heat and cool each separately.
- Press the **MENU** button (If menu does not appear first, press **RUN SCHED**).
- Press **SET SCHED**. **Note:** Monday-Friday is displayed and the **OCCUPIED** text is shown. You are now programming the **OCCUPIED** time period for the weekday setting.
- Use the  or  key to make your time selection for the weekday **OCCUPIED** time period.
Note: If you want the fan to run continuously during this time period, select **ON** with the **FAN** key.
- Then use the  or  key to make your setpoint selection for the weekday **OCCUPIED** period.
- Press **Next Step**.
- Repeat steps 4 through 7 for the weekday **UNOCCUPIED** time period.

Saturday:





Repeat steps 4 through 7 for the Saturday **OCCUPIED** time period and for the Saturday **UNOCCUPIED** time period.

Sunday:

Repeat steps 4 through 7 for the Sunday **OCCUPIED** time period, and for the Sunday **UNOCCUPIED** time period.

To customize your 7 day program schedule, follow these steps:

Monday:

- Select **HEAT** or **COOL** with the **SYSTEM** key.
Note: You have to program heat and cool each separately.
- Press the **MENU** button (If menu does not appear first press **RUN SCHED**).
- Press **SET SCHED**. **Note:** Monday is displayed and the **OCCUPIED** text is shown. You are now programming the **OCCUPIED** time period for that day.
- Time is flashing. Use the  or  key to make your time selection for that day's **OCCUPIED** time period.
Note: If you want the fan to run continuously during this time period, select **ON** with the **FAN** key.
- Then use the  or  key to make your setpoint selection for that day's **OCCUPIED** period.
- Press **NEXT STEP**.
- Repeat steps 4 through 7 for that day's **UNOCCUPIED** time period.

Repeat steps 4 through 7 for the remaining days of the week.

A Note About Programmable Fan:





The programmable fan feature will run the fan continuously during any time period it is programmed to be on. This is the best way to keep the air circulated and to eliminate hot and cold spots in your building.

Set Program Schedule For Four Time Periods

(WAKE, LEAVE, RETURN, SLEEP or OCCUPIED 1, UNOCCUPIED1, OCCUPIED 2, UNOCCUPIED 2)

To customize your 5+1+1 Program schedule, follow these steps:

Weekday:

1. Select **HEAT** or **COOL** with the system key.
Note: You have to program heat and cool each separately.
2. Press the **MENU** button (If menu does not appear first press **RUN SCHED**).
3. Press **SET SCHEDULE**. **Note:** Monday-Friday is displayed and the **WAKE/OCC1** icon is shown. You are now programming the **WAKE/OCC1** time period for the weekday setting.
4. Use the  or  key to make your time selection for the weekday **WAKE/OCC1** time period.
Note: If you want the fan to run continuously during this time period, select **ON** with the **FAN** key.
5. Then use the  or  key to make your setpoint selection for the weekday **WAKE/OCC1** period.
6. Press **Next Step**.
7. Repeat steps 4 through 6 for the weekday **LEAVE/UNOCC1** time period, **RETURN/OCC2** time period, and for the weekday **SLEEP/UNOCC2** time period.

Saturday:





Repeat steps 4 through 6 for the Saturday **WAKE/OCC1** time period, **LEAVE/UNOCC1** time period, **RETURN/OCC2** time period, and for the Saturday **SLEEP/UNOCC2** time period.

Sunday:

Repeat steps 4 through 6 for the Sunday **WAKE/OCC1** time period, **LEAVE/UNOCC1** time period, **RETURN/OCC2** time period, and for the Sunday **SLEEP/UNOCC2** time period.

To customize your 7 day Program schedule, follow these steps:

Monday:

1. Select **HEAT** or **COOL** with the **SYSTEM** key.
Note: You have to program heat and cool each separately.
2. Press the **MENU** button (If menu does not appear first, press **RUN SCHED**).
3. Press **SET SCHED**. **Note:** Monday is displayed and the **WAKE/OCC1** icon is shown. You are now programming the **WAKE/OCC1** time period for that day.
4. Use the  or  key to make your time selection for that day's **WAKE/OCC1** time period.
Note: If you want the fan to run continuously during this time period, select **ON** with the **FAN** key.
5. Then use the  or  key to make your setpoint selection for that day's **WAKE/OCC1** period.
6. Press **Next Step**.
7. Repeat steps 4 through 7 for that day's **LEAVE/UNOCC1** time period, for that day's **RETURN/OCC2** time period, and for that day's **SLEEP/UNOCC2** time period.

Repeat steps 4 through 7 for the remaining days of the week.



A Note About Auto Changeover:



In Auto you have the ability to switch between Auto Heat or Auto Cool by pressing the system key. This can be done once the current mode has reached its setpoint. For example: if in Auto Heat, the heat setpoint must be satisfied before the thermostat will allow you to switch to Auto Cool. You can switch out of Auto by holding down the **SYSTEM** key. To get back into Auto, you must toggle the system key to Auto.

Features

Features

Temporary & Permanent Hold Feature

Temporary Hold: The thermostat will display **HOLD** and **Run Schedule** on the bottom of the screen when you press the  or  key. If you do nothing, the temperature will remain at this setpoint temporarily for 4 hours. The program setpoint will then replace the temporary setpoint.

Permanent Hold: With a temporary hold set, If you press the **HOLD** key at the bottom of your screen, you will see **HOLD** appear next to the setpoint temperature in the display. The thermostat will now permanently stay at this setpoint and can be adjusted using the  or  keys.

To Return To Program: Press the **Run Schedule** key at the bottom of the screen to exit temporary and permanent holds.

Filter Change Reminder

If your installing contractor has configured the thermostat to remind you when the air filter needs changed, you will see a reminder in the display when your air filter needs changed. the reminder will be shown in the display after your system has run long enough to require an air filter change.

Resetting the filter change reminder: When the reminder is displayed, you should change your air filter and reset the reminder by holding down the **"Clean"** key on the left side of the thermostat for 3 seconds.

Specifications

Specifications

The display range of temperature ...	41°F to 95°F (5°C to 35°C)
The control range of temperature....	44°F to 90°F (7°C to 32°C)
Load Rating.....	1 amp per terminal, 1.5 amp maximum all terminals combined
Swing (cycle rate or differential)	Heating is adjustable from 0.2° to 2.0° Cooling is adjustable from 0.2° to 2.0°
Power source	18 to 30 VAC, NEC Class II, 50/60 Hz for hardwire Battery power from 2 AA Alkaline batteries
Operating ambient	32°F to +105°F (0°C to +41°C)
Operating humidity	90% non-condensing maximum
Dimensions of thermostat	4.7" W x 4.3" H x 1.1" D