



TP-N-601

Vive Comfort

P.O. Box 3377
 Springfield, MO 65808-3377
 Toll Free : 888-776-1427
 Web: www.vivecomfort.com
 Hours of Operation: M-F 9AM - 6PM Eastern

Thermostat Application Guide

Description	
Gas or Oil Heat	Yes
Electric Furnace	Yes
Heat Pump (No Aux. or Emergency Heat)	Yes
Heat Pump (With Aux. or Emergency Heat)	No
Multi-Stage Systems	No
Heat Only Systems	Yes
Heat Only Systems - Floor or Wall Furnace	Yes
Cool Only Systems	Yes
Millivolt	Yes

Power Type

Battery Power
 Hardwire (Common Wire)
 Hardwire (Common Wire) with Battery Backup

A trained, experienced technician must install this product.

Carefully read these instructions. You could damage this product or cause a hazardous condition if you fail to follow these instructions.

Una version en español de este manual se puede descargar en la pagina web de la compañía.

Table of Contents

Page	
1	Specifications
2-3	Installation Tips
4	Thermostat Quick Reference
5	Wiring
6	Wiring Diagrams
7-8	Technician Setup

Specifications

The display range of temperature ... 41°F to 95°F (5°C to 35°C)
 The control range of temperature... 44°F to 90°F (7°C to 32°C)
 Swing (cycle rate or differential) Heating is adjustable from 0.2° to 2.0°
 Cooling is adjustable from 0.2° to 2.0°
 Power source 18 to 30 VAC, NEC Class II, 50/60 Hz for hardwire
 Battery power from 2 AA Alkaline batteries
 Operating ambient 32°F to +105°F (0°C to +41°C)
 Operating humidity 90% non-condensing maximum
 Dimensions of thermostat 4.7"W x 4.4"H x 0.8"D

1 © U.S. Registered Trademark. Patents pending
 Copyright © 2018 All Rights Reserved.

Rev. 1814

Wall Locations

The thermostat should be installed approximately 4 to 5 feet above the floor. Select an area with average temperature and good air circulation.

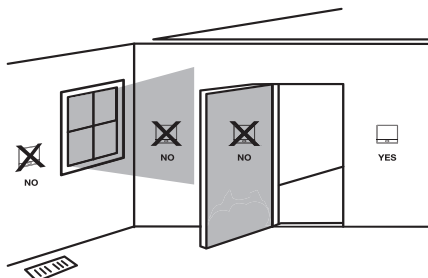

Installation Tip

Pick an installation location that is easy for the user to access. The temperature of the location should be representative of the building.

Do not install thermostat in locations:

- Close to hot or cold air ducts
- That are in direct sunlight
- With an outside wall behind the thermostat
- In areas that do not require conditioning
- Where there are dead spots or drafts (in corners or behind doors)
- Where there might be concealed chimneys or pipes

Subbase Installation

- 1 Horizontal Mount
- 2 Vertical Mount

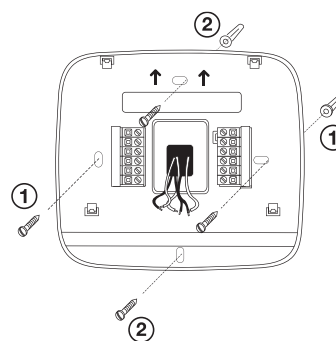

For vertical mount put one screw on the top and one screw on the bottom.
 For horizontal mount put one screw on the left and one screw on the right.



Installation Tip: Electrical Hazard

Failure to disconnect the power before beginning to install this product can cause electrical shock or equipment damage.



Mercury Notice

All of our products are mercury free. However, if the product you are replacing contains mercury, dispose of it properly. Your local waste management authority can give you instructions on recycling and proper disposal or you can mail the thermostat to the address on the warranty section for proper disposal.

Installation Tips

Mount Thermostat

Align the 4 tabs on the subbase with corresponding slots on the back of the thermostat, then push gently until the thermostat snaps in place.

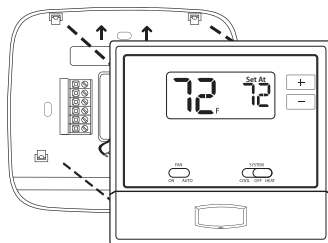

Battery Installation

Battery installation is recommended even if thermostat is hardwired (C terminal connected). When thermostat is hardwired and batteries are installed, the thermostat will activate a compressor delay of 5 minutes when the thermostat detects a power outage from the hardwired power supply.

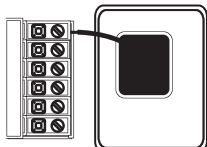

Important:

High quality alkaline batteries are recommended. Rechargeable batteries or low quality batteries do not guarantee a 1-year life span.

Insert 2 AA Alkaline batteries (included). High quality alkaline batteries are recommended.

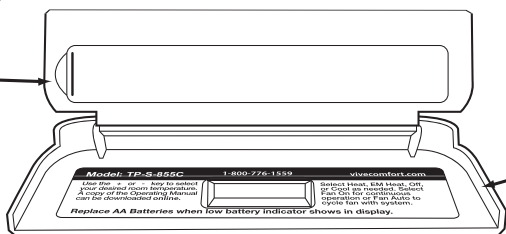

Simple operating instructions are found on the back of the battery door.

Gas or Electric Setup

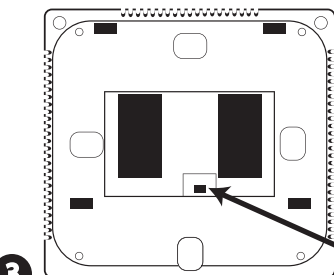

Gas: For systems that control the fan during a call for heat, put the fan operation switch to the GAS position.
Electric: For systems that do not control the fan during a call for heat, put the fan operation switch to the ELECTRIC position.

Fan Operation Switch

Getting to know your thermostat

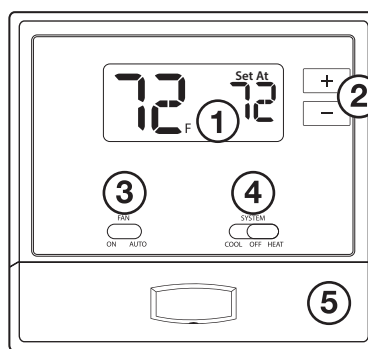

- 1 LCD
- 2 Temperature setpoint buttons
- 3 Fan switch
- 4 System switch
- 5 Easy change battery door

System Operation Indicators:

The COOL ON, HEAT ON icon will display when the COOL, HEAT is on.

Displays the selected setpoint temperature.



Indicates the current room temperature.
Low Battery Indicator: Replace batteries when indicator is shown.

NOTE: The compressor delay feature is active if these icons are flashing. The compressor will not turn on until the 5 minute delay has elapsed.



Important

The low battery icon is displayed when the AA battery power is low. Whenever the thermostat detects low battery voltage from the AA batteries, the low battery icon will begin flashing on the screen for 21 days (if the batteries are not changed). If the batteries are not changed 22 days after the thermostat detects low battery voltage, the thermostat screen will only show the flashing battery icon until buttons are pressed. If the batteries are not changed 43 days after the thermostat detects low battery voltage, the thermostat screen will only show the flashing battery icon until buttons are pressed and the set points will offset to 85°F/29°C in cooling and 55°F/13°C in heating. At this stage, set point changes can be made temporarily but, the set points will change back to defaulted values after a 4-hour period. The thermostat will continue to perform this low battery flashing, temperature offset condition until the internal voltage threshold is reached. When the thermostat internal voltage threshold is reached, all relays will be opened and the thermostat will become inoperable until new batteries are installed.

Removing The Private Label Badge

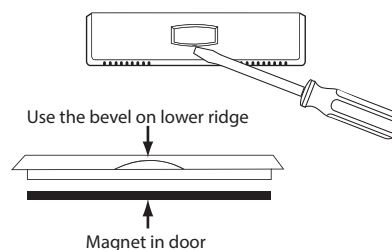

About The Badge

All of our thermostats use the same universal magnetic badge. Visit the company website to learn more about our free private label program.



Caution: Electrical Hazard

Failure to disconnect the power before beginning to install this product can cause electrical shock or equipment damage.



Warning:

All components of the control system and the thermostat installation must conform to Class II circuits per the NEC Code.

Wiring

1. If you are replacing a thermostat, make note of the terminal connections on the thermostat that is being replaced. In some cases the wiring connections will not be color coded. For example, the green wire may not be connected to the **G** terminal.
2. Loosen the terminal block screws. Insert wires then retighten terminal block screws.
3. Place nonflammable insulation into wall opening to prevent drafts.



Installation Tip

Do not overtighten terminal block screws, as this can damage the terminal block. A damaged terminal block can keep the thermostat from fitting on the subbase correctly or cause system operation issues.

Max Torque = 6in-lbs.

Terminal Designations

- C** Common wire from secondary side of cooling system transformer
- O** Heat pump changeover valve energized in cooling
- B** Heat pump changeover valve energized in heating
- W** Heat relay
- RH** Transformer power for heating
- RC** Transformer power for cooling
- G** Fan relay
- Y** Compressor relay

Wiring Tips

RH & RC Terminals

For single transformer systems, leave the jumper wire in place between RH and RC. Remove jumper wire for two transformer systems.

Heat Pump Systems (With NO AUX or Emergency Heat)

If wiring to a heat pump, use a small piece of wire (not supplied) to connect terminals W and Y.

C Terminal

The C (common wire) terminal does not have to be connected when the thermostat is powered by batteries.

Wire Specifications

Use shielded or non-shielded 18-22 gauge thermostat wire.



1 Power supply



2 Factory-installed jumper. Remove only when installing on 2-transformer systems



3 Use either **O** or **B** terminals for changeover valve



4 Use a small piece of wire (not supplied) to connect **W** and **Y** terminals



5 Set fan operation switch to Electric



6 Optional 24 VAC common connection when thermostat is used in battery power mode

Typical 1H/1C System: 1 Transformer

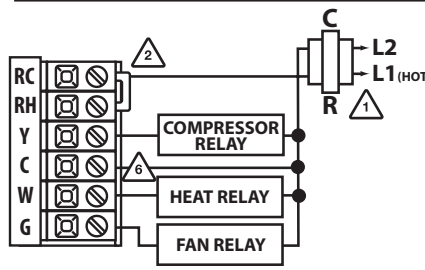

Typical 1H/1C System: 2 Transformer

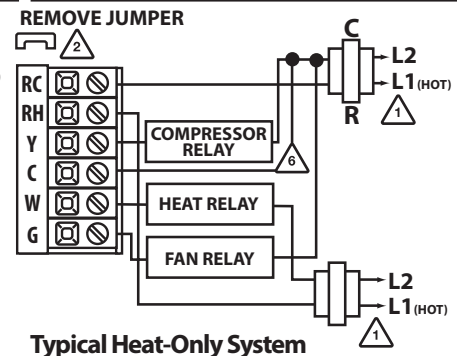

Typical 1H/1C Heat Pump System

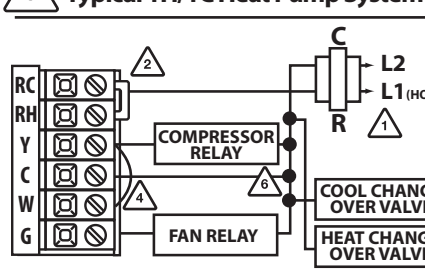

Typical Heat-Only System

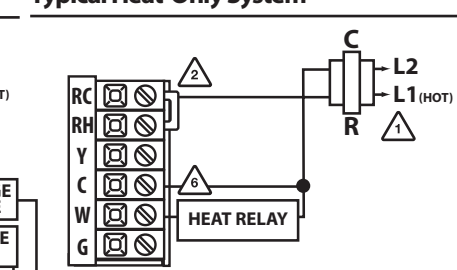

Typical Heat Only System With Fan

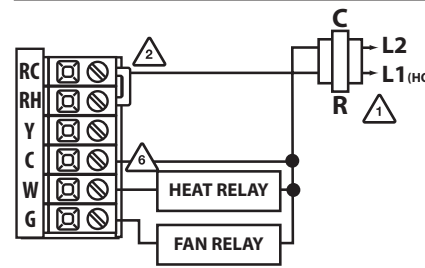

Typical Cool-Only System

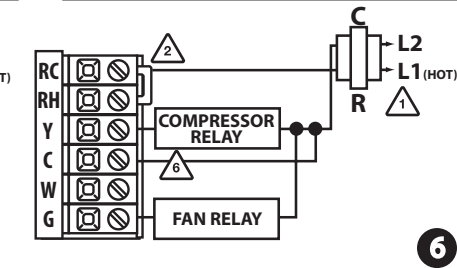

Technician Setup

Tech Settings

1. Select OFF with the System Switch.
2. Press and hold the + and - buttons together for 3 seconds.
3. Use the + and - to change setting for that step, press the + and - simultaneously to change between tech settings.

To exit Tech Settings, slide the System Switch to a different position or wait approximately 20 seconds.

Tech Settings	LCD Will Show	Adjustment Options	Default
Room Temperature Calibration	CR 0	You can adjust the room temperature display to read 4° above or below the factory calibrated reading.	0
Compressor Short Cycle Delay	CD 07	Selecting "ON" will not allow the compressor to be turned on for 5 minutes after the last time the compressor was switched off. Select "OFF" to remove this delay.	ON
F or C	FC OF	F for Fahrenheit C for Celsius	F



Swing & Limit Settings

1. Select Heat or Cool with the System Switch.
2. Press and hold the + and - buttons together for 3 seconds.
3. Use the + and - to change setting for that step, press the + and - simultaneously to change between tech settings.

To exit Swing & Limit Settings, slide the System Switch to a different position or wait approximately 20 seconds.

Swing & Limit Settings	LCD Will Show	Adjustment Options	Default
Cooling Swing	CO 0.5	The swing setting often called "cycle rate", "differential" or "anticipation" is adjustable. A smaller swing setting will cause more frequent cycles and a larger swing setting will cause fewer cycles.	0.5
Cooling Setpoint Limit	L 44	This feature allows you to set a minimum cool setpoint value. The setpoint temperature can't be lowered below this value.	44
Heating Swing	HE 0.4	The swing setting often called "cycle rate", "differential" or "anticipation" is adjustable. A smaller swing setting will cause more frequent cycles and a larger swing setting will cause fewer cycles.	0.4
Heating Setpoint Limit	H 90	This feature allows you to set a maximum heat setpoint value. The setpoint temperature can't be raised above this value.	90

Swing Setting Tip

Temperature swing, sometimes called differential or cycle rate, can be customized for this individual application. For most applications choose a swing setting that is as wide as possible without making the occupants uncomfortable.

