

VIVE TP-N-501M

COMFORT

Vive Comfort

P.O. Box 3377
 Springfield, MO 65808-3377
 Toll Free : 888-776-1427
 Web: www.vivecomfort.com
 Hours of Operation: M-F 9AM - 6PM Eastern

Thermostat Application Guide

For Use On

- Most 24V Heating and A/C Systems
- Gas or Oil Heat
- Electric Furnace
- Heat Pump With NO Auxiliary Heat
- Heat Only Systems
- Cool Only Systems
- Millivolt Systems

NOT For Use On

- Multi Stage Systems
- Line Voltage Systems
- Compressors With No Built In Delay
- 3 Wire Hydronic Systems

Specifications

Power Source	18-30 VAC
Load Rating.....	1 AMP per terminal, 1.5 AMP maximum on all terminals combined
Operating Humidity	90% Non-condensing maximum
Heat anticipator range	0.15A to 1.2A
Cool anticipator range	Fixed
Millivolt	0.15A for 0.75 VDC systems
Temperature range	50° - 90° F (10° - 32° C)

1 *U.S. Registered Trademark. Patents pending
 Copyright ©2018 All Rights Reserved.

Rev. 1810

A trained, experienced technician must install this product.

Carefully read these instructions. You could damage this product or cause a hazardous condition if you fail to follow these instructions.

Wall Locations

The thermostat should be installed approximately 4 to 5 feet above the floor. Select an area with average temperature and good air circulation.

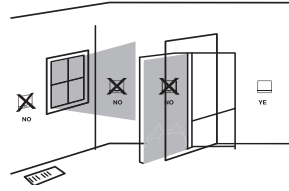

Installation Tip

Pick an installation location that is easy for the user to access. The temperature of the location should be representative of the building.

Mercury Notice

All of our products are mercury free. However, if the product you are replacing contains mercury, dispose of it properly. Your local waste management authority can give you instructions on recycling and proper disposal.

Do not install thermostat in locations:

- Close to hot or cold air ducts
- That are in direct sunlight
- With an outside wall behind the thermostat
- In areas that do not require conditioning
- Where there are dead spots or drafts (in corners or behind doors)
- Where there might be concealed chimneys or pipes

Installation Tip: Electrical Hazard

Failure to disconnect the power before beginning to install this product can cause electrical shock or equipment damage.

Private Label Badge

Subbase Installation

- 1 Horizontal Mount
- 2 Vertical Mount

For horizontal mount, install one left screw and one right screw. For vertical mount, install one top screw and one bottom screw.

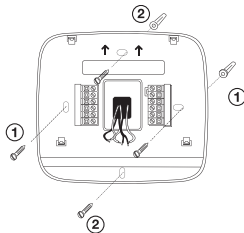

Removing The Private Label Badge

Gently slide a screwdriver into the bottom edge of the badge. Gently turn the screwdriver counter clockwise. The badge is held on by a magnet in the front plastic. The badge should pry off easily. **DO NOT USE FORCE.**

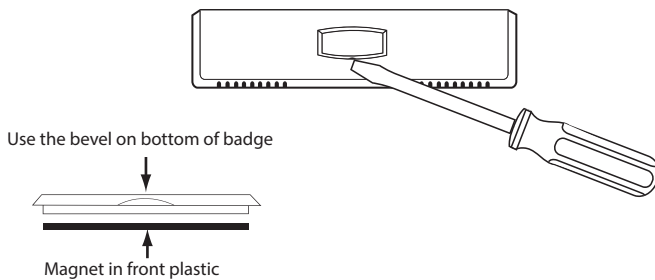

About The Badge

All of our thermostats use the same universal magnetic badge. Visit the company website to learn more about our free private label program.

Wiring

Caution: Electrical Hazard

Failure to disconnect the power before beginning to install this product can cause electrical shock or equipment damage.

Warning:

All components of the control system and the thermostat installation must conform to Class II circuits per the NEC Code.

Wiring

1. If you are replacing a thermostat, make note of the terminal connections on the thermostat that is being replaced. In some cases the wiring connections will not be color coded. For example, the green wire may not be connected to the G terminal.
2. Loosen the terminal block screws. Insert wires then retighten terminal block screws.
3. Place nonflammable insulation into wall opening to prevent drafts.

Installation Tip

Do not overtighten terminal block screws, as this can damage the terminal block. A damaged terminal block can keep the thermostat from fitting on the subbase correctly or cause system operation issues.

Max Torque = 6in-lbs.

Terminal Designations

- O** Heat pump changeover valve energized in cooling
- B** Heat pump changeover valve energized in heating
- W** Heat relay
- RH** Transformer power for heating
- RC** Transformer power for cooling
- G** Fan relay
- Y** Compressor relay

Wiring Tips

RH & RC Terminals

For single transformer systems, leave the jumper wire in place between the RH and RC. Remove jumper wire for two transformer systems.

Heat Pump Systems (With NO AUX or Emergency Heat)

If wiring to a heat pump, use a small piece of wire (not supplied) to connect terminals W and Y.

Wire Specifications

Use 18-22 gauge thermostat wire.

- 1 Power supply
- 2 Factory-installed jumper. Remove only when installing on 2-transformer systems
- 3 Use either O or B terminals for changeover valve
- 4 Use a small piece of wire (not supplied) to connect W and Y terminals

Typical 1H/1C System: 1 Transformer

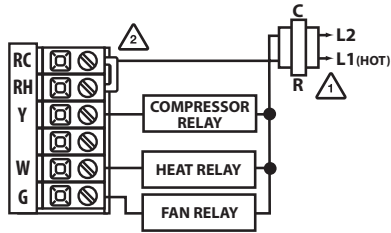

Typical 1H/1C System: 2 Transformer

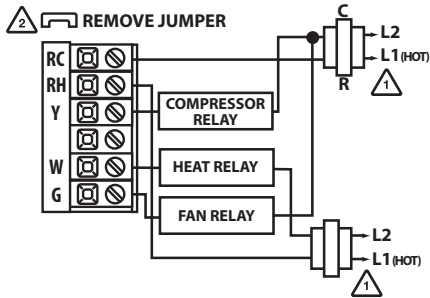

Typical 1H/1C Heat Pump System

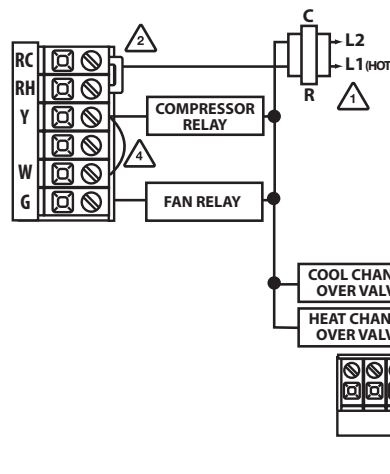

Typical Heat-Only System

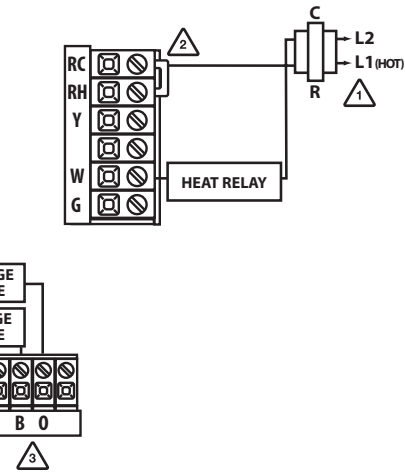

Typical Heat Only System With Fan

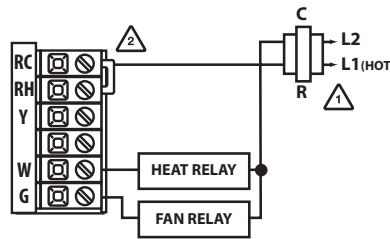

Typical Cool-Only System

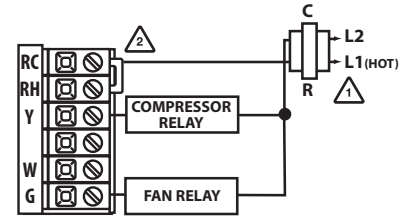

Removing & Replacing The Front Cover

Remove Front Cover

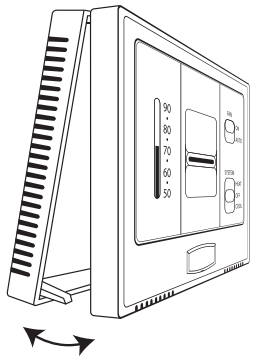

Note: To access the faceplate, pull the cover off from the front of thermostat.

Faceplate Application Options

1 HEAT - OFF
COOL

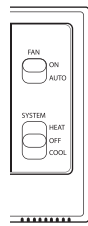

2 HEAT ONLY
WITH FAN

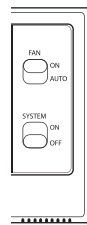

3 HEAT ONLY
WITHOUT FAN

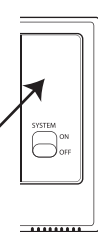

For HEAT ONLY without FAN:
Put the GAS/ELEC switch in the GAS position (Left).

Put the FAN in the AUTO (down) position. Then pull the FAN button off the switch. The faceplate will then cover and hide the FAN switch.

Replacing Application Faceplates

To remove faceplate from the front cover, press the back of the faceplate near the edge of the front cover until the faceplate snaps out of its place. Replace different faceplate by placing the new faceplate in open space on the front of the front cover. Press the edge of the faceplate into the front of the front cover until it snaps into place.

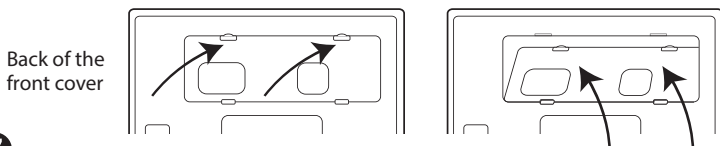

Anticipator Setting

Note

For accurate temperature control, the adjustable heat anticipator must be set correctly. The anticipator setting should match the current draw of the system in heat mode for best results.

Heating Anticipator Setting

Set the adjustable heat anticipator to match the current draw of the system in heat mode. With the thermostat wired to the HVAC system and mounted on the wall, remove the thermostat from the subbase. Place ammeter probes on the RH and W terminals. After one minute of heating runtime, the ammeter will show a steady current draw value. This current draw value in milliamps on the ammeter is the same value that the anticipator needs to be set to for best results. Set anticipator dial to match the steady ammeter reading in milliamps.

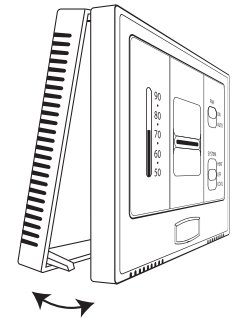

To access heat anticipator adjustment arm, pull the cover off from the front of thermostat.

Anticipator Settings

Higher anticipator values will allow longer running heat cycles.

Lower anticipator values will allow shorter running heat cycles.

Note: For millivolt systems, set anticipator to its lowest setting.

